

SPICE thermal model

BUK768R3-60E

Symbol	Parameter	Conditions	Min	Typ	Max	Unit
$R_{th(j-mb)}$	thermal resistance from junction to mounting base		-	-	1.09	K/W

C_{th1}	7.777E-05 F
C_{th2}	5.590E-04 F
C_{th3}	4.173E-04 F
C_{th4}	1.668E-03 F
C_{th5}	4.591E-03 F
C_{th6}	1.183E-02 F
C_{th7}	5.894E-01 F
C_{th8}	6.237E+01 F
R_{th1}	1.138E-03 Ω
R_{th2}	2.238E-03 Ω
R_{th3}	2.653E-02 Ω
R_{th4}	6.359E-02 Ω
R_{th5}	2.437E-01 Ω
R_{th6}	6.823E-01 Ω
R_{th7}	9.785E-02 Ω
R_{th8}	3.577E-03 Ω

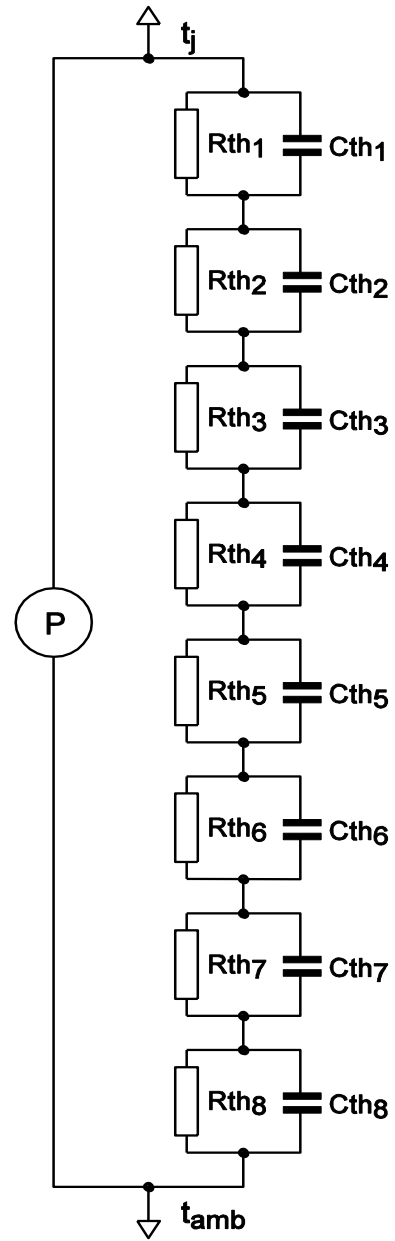

Part: BUK768R3-60E
 Date: 11/4/2013
 Model Rth 1.12 K/W